

NOTE 1)

No.	PART NAME	MATERIAL	Qt'y	SIZE	REMARK
01					

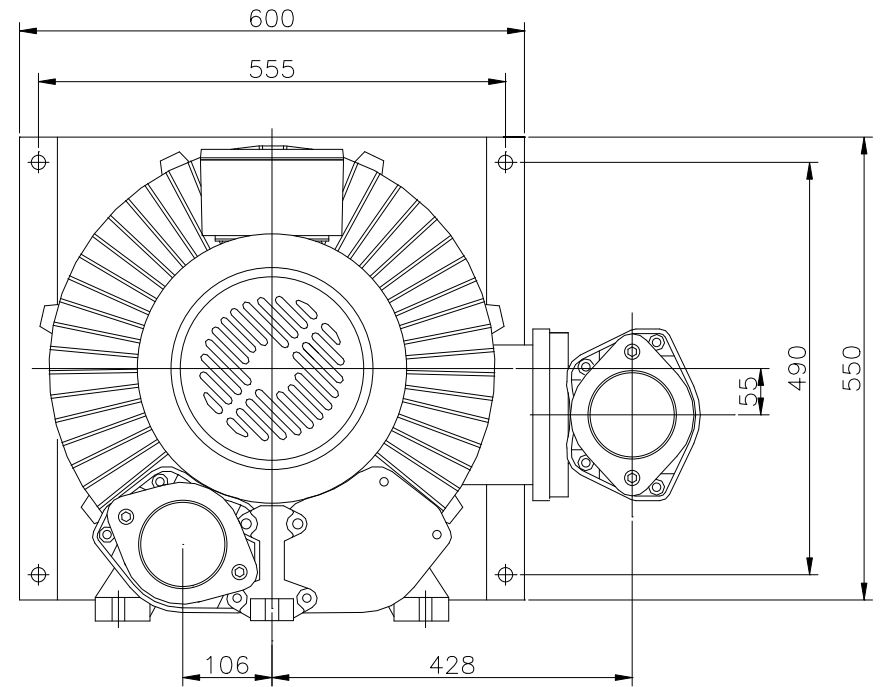
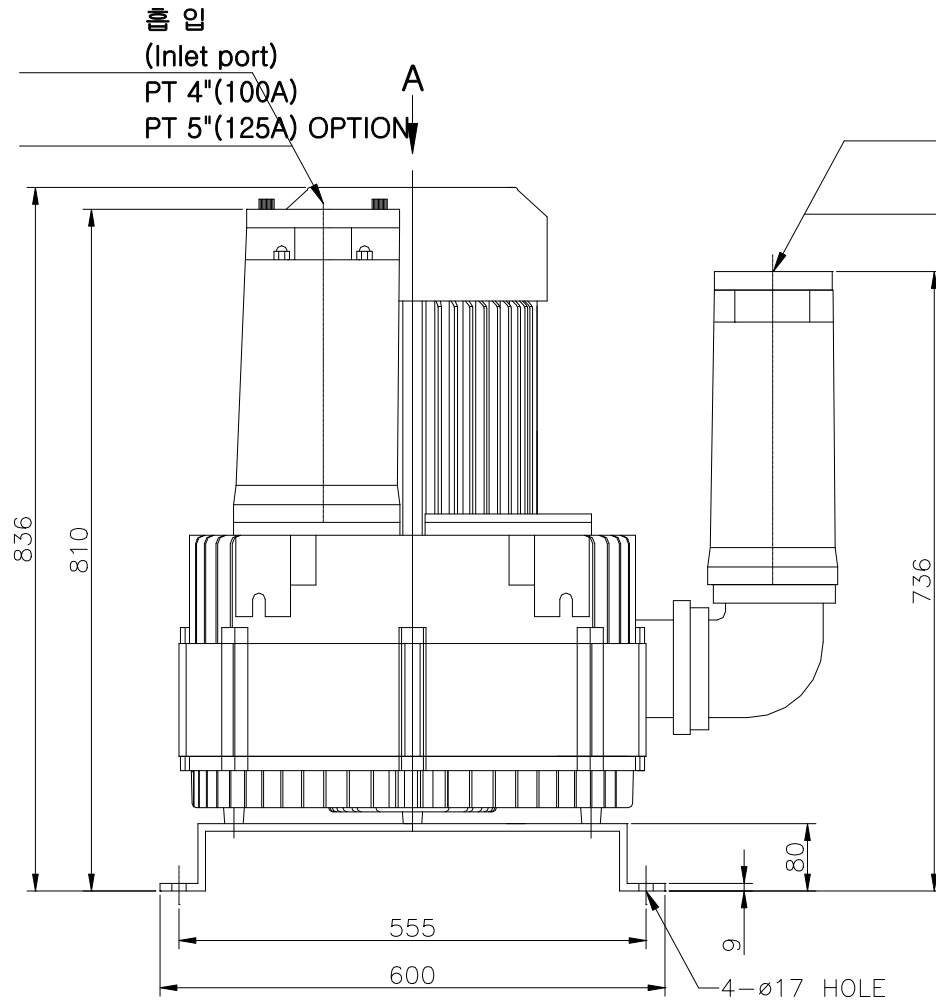

View A

△				00					
No.	Revision			Date	Draw	Check	Appr.		
형식 TYPE	HRBV-1402			도명 TITLE	OUTWARD DWG.				
DRAWN	DESIGN	CHECKED	APPROVED	3RD ANGLE	SCALE:1/1	UNIT:mm			
B.S.Kim				SIZE	3Ø 2P 18.5Kw				
09.06.30									
黃海電機 HWANG HAE ELECTRIC				도번 DWG. No.	BOD00039				

