

NOTE 1)

No.	PART NAME	MATERIAL	Qt'y	SIZE	REMARK
01					

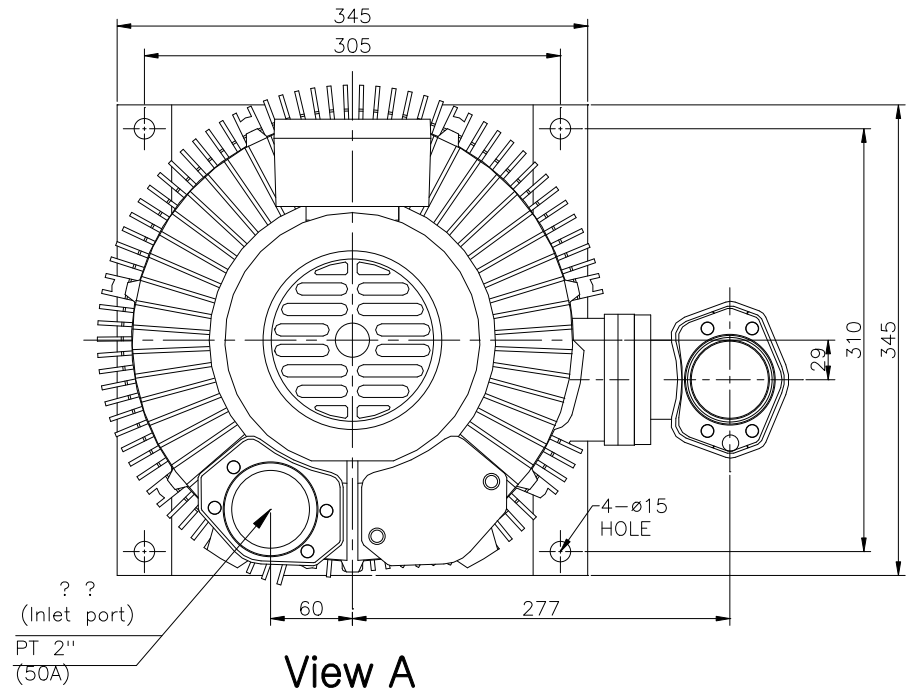
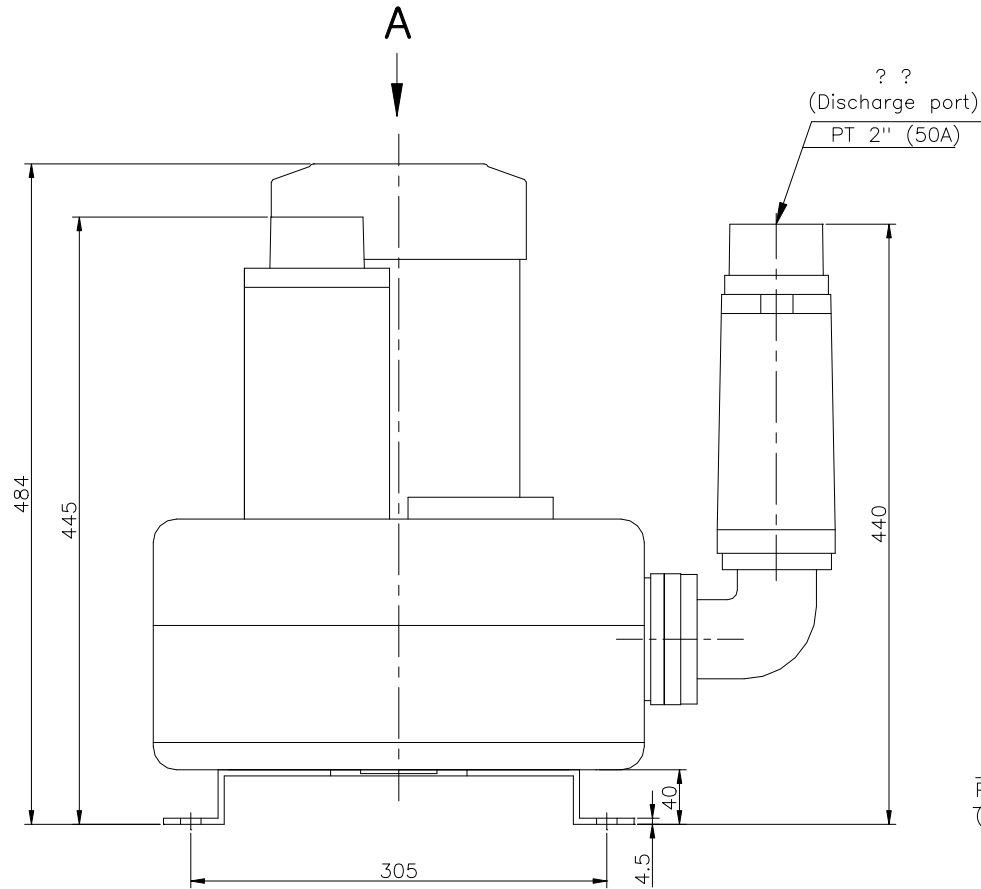

View A

△						00			
No.	Revision					Date	Draw	Check	Appr.
형식 TYPE	HRBV-602				도명 TITLE	OUTWARD DWG.			
DRAWN	DESIGN	CHECKED	APPROVED	3RD ANGLE	SCALE:1/1	UNIT:mm			
B.S.Kim					SIZE	3Ø 2P 3.7Kw			
09.09.11									
黃海電機 HWANG HAE ELECTRIC					도번 DWG. No.	BOD00145		△	

