

NOTE 1)

No.	PART NAME	MATERIAL	Qt'y	SIZE	REMARK
01					

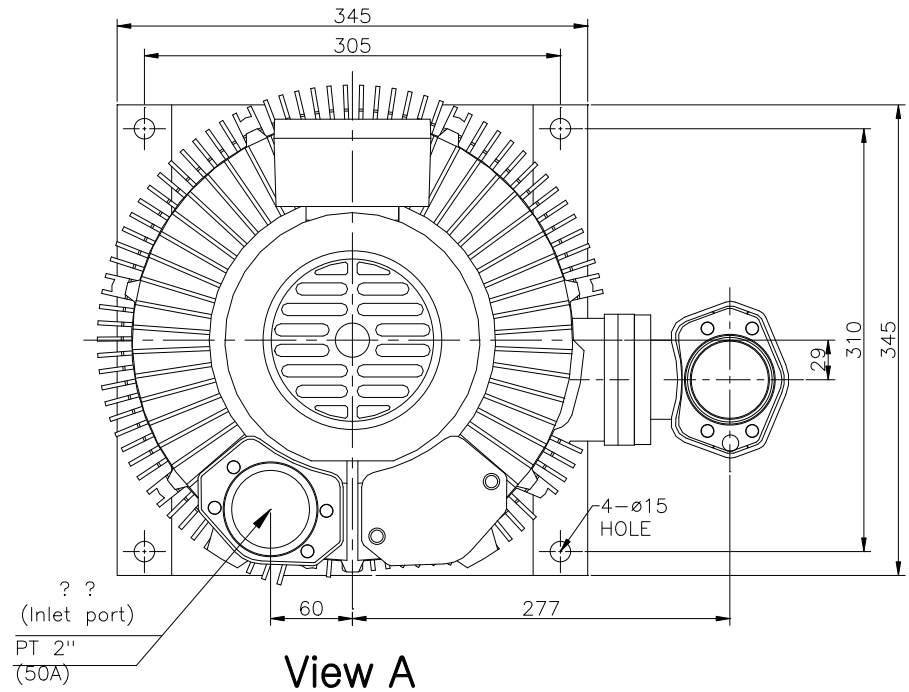
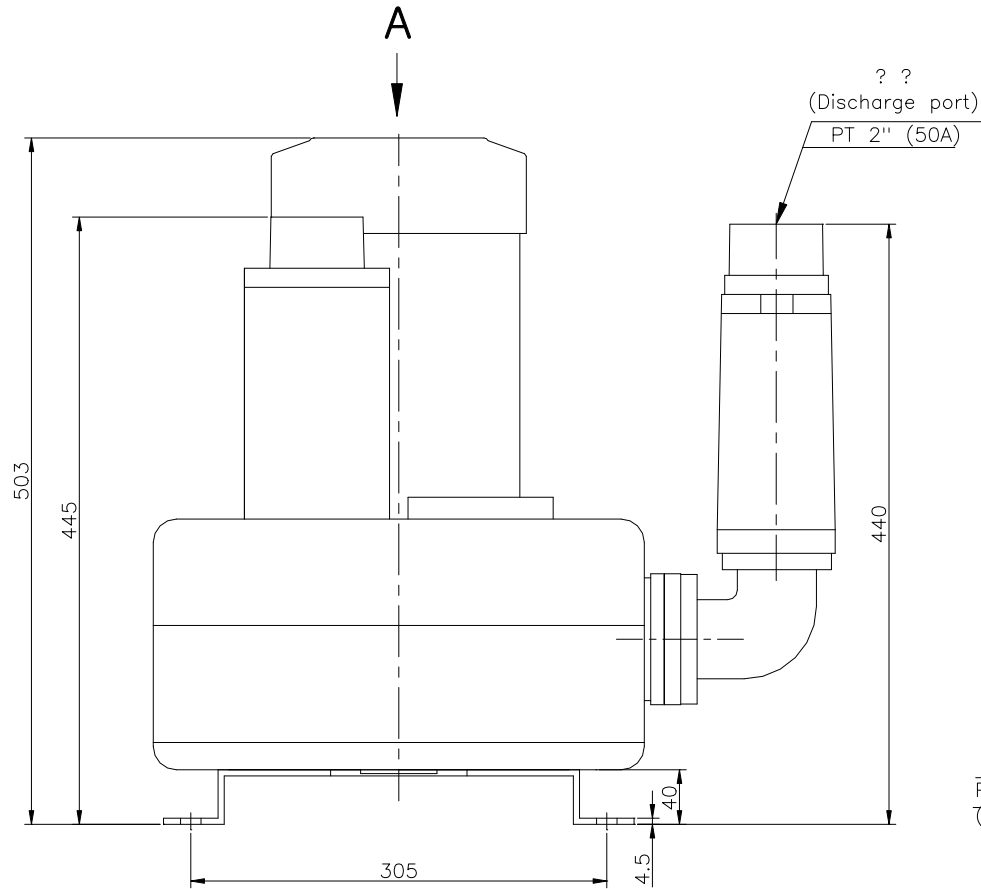

View A

△		00					
No.	Revision			Date	Draw	Check	Appr.
형식 TYPE	HRBV-702		도명 TITLE	OUTWARD DWG.			
DRAWN	DESIGN	CHECKED	APPROVED	3RD ANGLE	SCALE:1/1	UNIT:mm	
B.S.Kim				SIZE	3Ø 2P 4.6Kw		
09.09.11							
黃海電機 HWANG HAE ELECTRIC			도번 DWG. No.	BOD00142			

