

NOTE 1)

No.	PART NAME	MATERIAL	Qt'y	SIZE	REMARK
01					

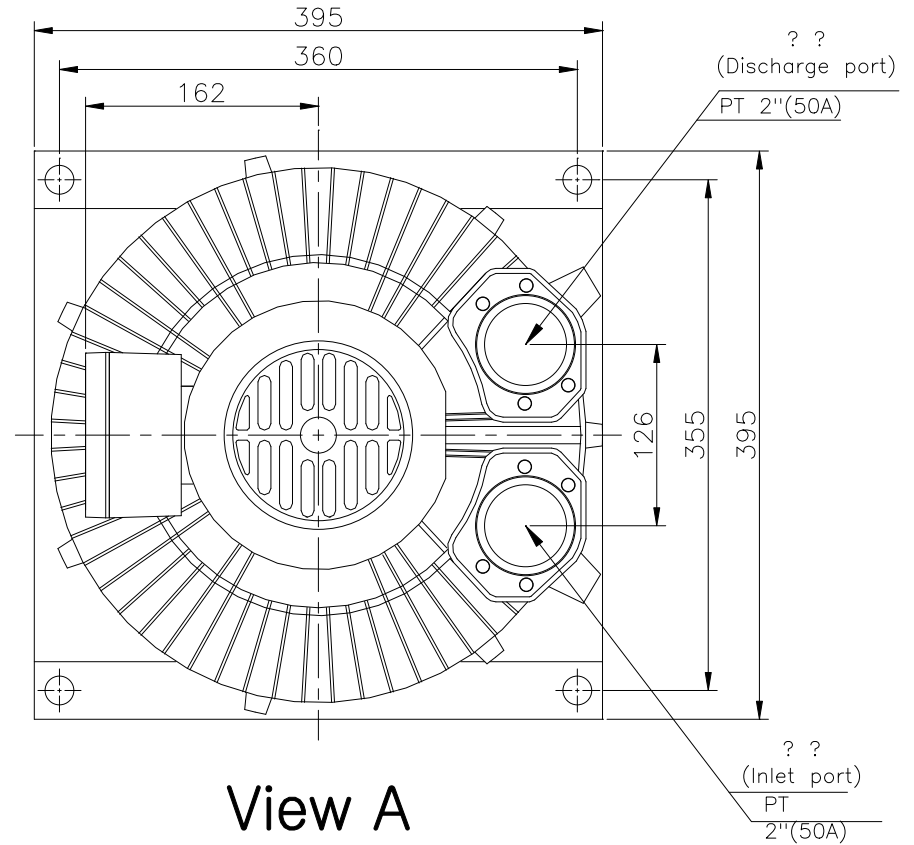
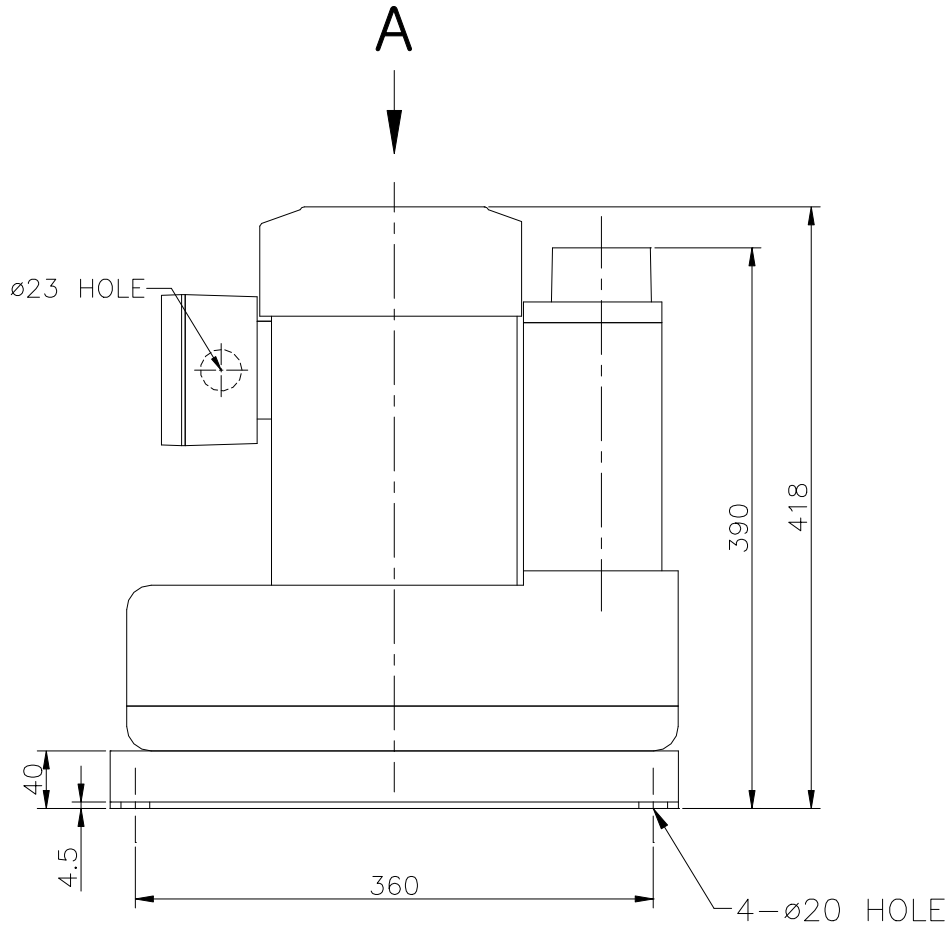

View A

△		Revision			00		Date	Draw	Check	Appr.
No.					Date	Draw	Check	Appr.		
형식 TYPE	HRBV-600			도명 TITLE	OUTWARD DWG.					
DRAWN	DESIGN	CHECKED	APPROVED	3RD ANGLE	SCALE:1/1	UNIT:mm				
B.S.Kim				SIZE	3Ø 2P 3.7Kw					
13.05.08										
黃海電機 HWANG HAE ELECTRIC				도번 DWG. No.	BOD00300					

